

Eldorado

RIDER'S HANDBOOK

SEIMM

SOCIETÀ ESERCIZIO INDUSTRIE MOTOMECCANICHE S.p.A.

Capitale sociale: L. 2.600.000.000 interamente versato

Sede legale: Milano

Registro Imprese Milano N. 130902

Direzione e Stabilimenti: 22054 Mandello del Lario (CO)

Telefoni: 71112 e 72512 (8 linee urbane)

Telegrammi: SEIMM MANDELLOLARIO

Telex: 38095 SEIMM



MOTO GUZZI

C.C.I.A.A. Milano N. 722044 - Como N. 117437 ■ C.C. Postale Como N. 18/4226 ■ Posizione Commercio Estero M 986753



II^a EDITION

RIDER'S HANDBOOK



INTRODUCTION

This booklet is intended to provide owners with the necessary information on operating and maintaining their machines for maximum efficiency.

The manual should be read very carefully as most troubles and failures arising from neglect or poor maintenance will be avoided if all the instructions herein contained are strictly followed.

Don't forget that all major overhaul jobs and repairs are best carried out by officially appointed Moto Guzzi dealers who have the necessary facilities to quickly and competently repair your Moto Guzzi.



INDEX

Running in	page 5
Controls and accessories	7
Identification data	10
Tool kit	11
Main features - Engine	12
Transmission	15
Frame	15
Instruments and controls	18
Ignition key	19
Starting button	20
Steering lock	20
Light switch and horn button	20
Clutch lever	21
Twist grip throttle control	21
Carburetor starter control	21
Gearshift lever	21
Front brake lever	21
Rear brake pedal	21
Side stand	22
Riding instructions	23
Engine starting	23
Caution	23
Starting a hot engine	26
Getting under way and stopping of machine	26
On the way	26
Lubrication and general maintenance chart	28
Servicing instructions	30
Lubrication of engine	30
Oil pressure relief valve	31
Oil pressure gauge	31
Lubrication of transmission	32
Lubrication of rear wheel drive	32
Lubrication of front fork and hydraulic dampers	33
Lubrication of bevels in the steering	33
Lubrication of wheel bearings	34

Lubrication of control cables	page 34
Lubrication of rear fork bearings	" 34
Oil breather unit	" 34
Carburation	" 37
Carburetor	" 37
Standard carburetor setting	" 38
Adjusting the carburation	" 38
Stripping of carburetor	" 41
Air filter	" 43
Cleaning operations	" 44
Filters and fuel lines	" 44
Fuel tank	" 45
Fuel taps	" 45
Silencers	" 45
Cylinder heads, piston and valves	" 46
Valve gearing	" 48
Tappet clearance	" 48
Checking valve timing	" 48
Ignition	" 51
Distributor	" 51
Spark plugs	" 52
Checking of ignition timing	" 52
Checking of ignition advance by stroboscope lamp	" 53
Adjustments	" 56
Generator belt	" 56
Clutch lever	" 56
Steering	" 56
Steering lock	" 59
Front brake lever	" 60
Rear brake pedal	" 62
Rear suspension units	" 62
Checking the gear operating mechanism	" 63
Removal of wheels	" 65
Front wheel	" 65
Rear wheel	" 67
Electrical equipment	" 68
Wiring diagram	" 73

RUNNING IN

During the first 1600 kms. (1000 miles), a new or overhauled machine ought to be used with some intelligence as the efficiency, performance, and life of the engine are largely dependant on how it is run in.

The engine should never be allowed to reach a high number of revolutions before it has had a chance to warm up sufficiently. Never ride the machine at the highest permissible speeds for each gear before the machine has been well broken in.

Should the engine speed drop off considerably on an uphill grade, a lower gear should be immediately engaged. In case of overheating, it is best to stop and allow the engine to cool down.

Under no circumstances whatever should the following speeds be exceeded in the running in period.

Maximum permissible speeds:

Distance: up to 800 kms. (500 miles):

in low gear	45 kms. (28 miles)
in second gear	65 kms. (40 miles)
in third gear	85 kms. (53 miles)
in fourth gear	100 kms. (62 miles)
in top gear	115 kms. (72 miles)

from 800 to 1600 kms. (500 to 1000 miles):

in low gear	55 kms. (34,5 miles)
in second gear	80 kms. (50 miles)
in third gear	105 kms. (65 miles)
in fourth gear	120 kms (75 miles)
in top gear	140 kms. (87,5 miles)

From 1600 to 3000 kms. (1000 to 1800 miles) the speed can be gradually increased up to the maximum permissible limits.

**After the
first 500 kms.
(300 miles)**

Change the engine oil.
Tighten all nuts and bolts.
Check valve clearance.
Check distributor points.

**Every 500 kms.
(300 miles)**

Check oil level. Correct level is in between the minimum and maximum mark on the filler cap dipstick.

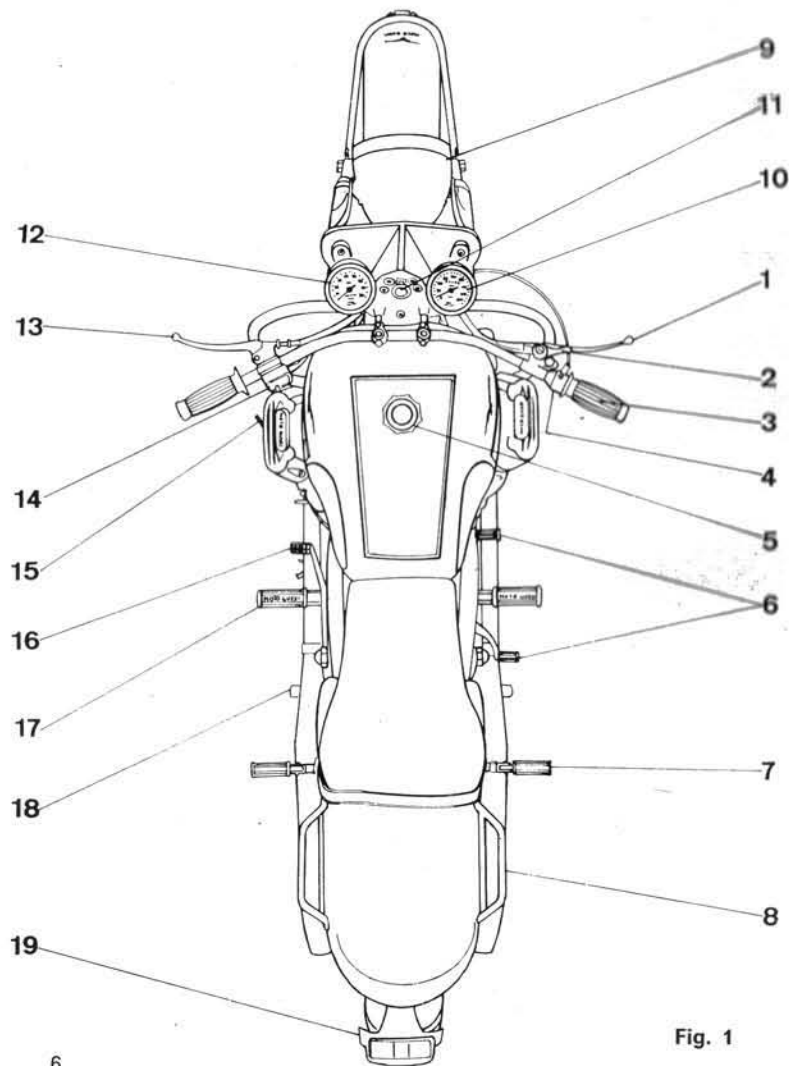

CONTROLS AND ACCESSORIES

(See fig. 1)

1. Front brake lever
2. Air control lever
3. Throttle control grip
4. Starter button
5. Filler cap
6. Gearshift lever
7. Pillion footrest
8. Pillion handgrip
9. Headlight
10. Speedometer
11. Ignition key
12. Rev-counter
13. Clutch lever
14. Light switch and horn button
15. Side stand
16. Rear brake pedal
17. Footrests
18. Center stand
19. Tail light

The machine can also be supplied with gearshift lever on the left and rear brake pedal on the right.

N.B. - The terms «right» and «left» in the text are used in the sense they would appear to one sitting in the saddle.

Fig. 1

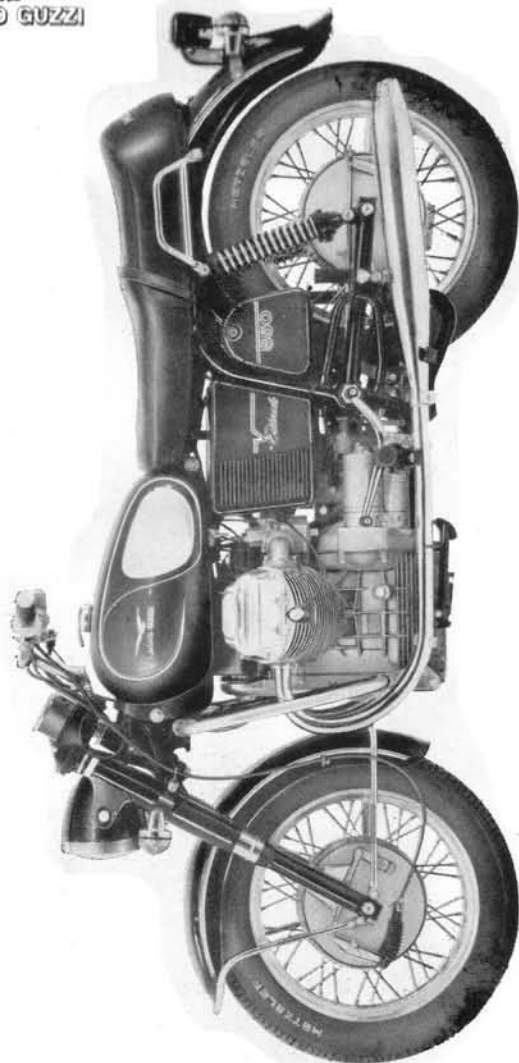

Fig. 2 - Left view



Fig. 3 - Right view

Identification data
(See fig. 4)

Every machine is identified with a serial number which is stamped on the frame down tube and on the left hand side of the crankcase cover.

This number appears in the conformity certificate and is the only one valid to all legal effects for the identification of the machine



Fig. 4

Tool kit
(See fig. 5)

- 10 - Wrench, box 19/21/22 mm
- 11 - Wrench, open ended 17/19 mm
- 12 - Wrench, open ended 13/14 mm
- 13 - Wrench, open ended 10/11 mm
- 14 - Wrench, open ended 7/8 mm
- 15 - Wrench, open ended, tappet adjusting
- 16 - Allen key, 5 hex
- 17 - Pliers, universal
- 18 - Screwdriver
- 19 - Wrench, ring, double 22/27 mm
- 20 - Feeler gauge
- 21 - Screwdriver
- 22 - Wrench, damper adjusting
- 23 - Tool bag
- 24 - Instruction booklet

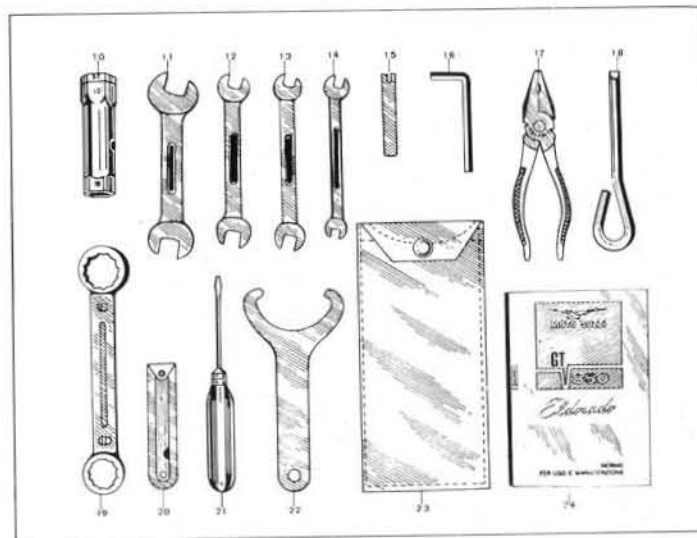

Fig. 5

MAIN FEATURES

ENGINE

(See fig. 5/1)

Cycle	:	4 strokes
Number of cylinders	:	2
Cylinder disposition	:	« V » 90°
Bore	:	83 mm (3.26")
Stroke	:	78 mm (3.07")
Displacement	:	844.05 cc. (51,5 cu.in.)

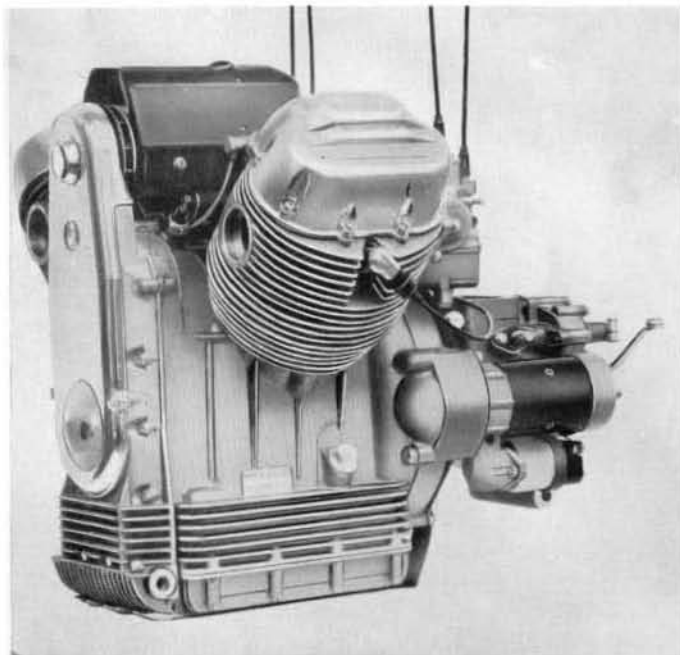

Fig. 5/1

Compression ratio	:	9.2 to 1
Revs at maximum engine speed	:	6500 r.p.m.
Output at maximum engine speed	:	64 HP SAE
Crankcase	:	in light alloy
Cylinders	:	in light alloy with hard chromed barrels
Cylinder heads	:	in light alloy, hemispherical, with special cast iron inserted seats
Crankshaft	:	steel construction
Crankshaft supports	:	in anti-friction material pressed in 2 suitable housings
Connecting rods	:	steel construction with AL-TIN alloy thin wall bearings
Pistons	:	in light alloy

Valve gear

O.H.V., push rod operated via the camshaft in the crankcase and gear driven by the crankshaft.

Inlet:

- opens 24° before TDC
- closes 58° after BDC

Exhaust:

- opens 58° before BDC
- closes 22° after TDC

Rocker clearance for valve timing:

- 0,5 mm. (.0196")

Normal rocker clearance (cold engine):

- inlet 0,15 mm. (.0059")
- exhaust 0,25 mm. (.0098")

Carburation

2 Dell'Orto carburetors type VHB 29 CD (right) and VHB 29 CS (left), both gravity fed from the tank.

Standard carburetor setting

- Choke : 29 mm.
- Throttle slide : 60
- Atomizer : 265
- Main jet : 145
- Pilot jet : 45
- Starter atomizer: 80

With needle SV5 second notch from top: idling screw open 1½ to 2 turns for the left carburetor and 2 - 2½ turns for the right carburetor.

Air intake provided with dry filter.

Lubrication

Pressure, by gear pump driven by the crank shaft.

Oil strainer in crankcase.

Normal lubrication pressure 3.8 - 4.2 kgs/sq. cm. (54 to 60 lbs sq.in.) controlled by relief-valve.

Electrically controlled oil pressure gauge.

Cooling

By air Cylinder and cylinder head deeply finned.

Ignition

By battery with automatic advance distributor.

Initial advance: 5°.

Automatic advance: 28°.

Ignition timing 33° full advance.

Contact breaker gap: 0.42-0.48 mm. (.016" - .018").

Spark plug: n. 225 in Bosch-Marelli scale or equivalent (long thread Ø 14 x 1,25).

Plugs point gap: 0.6 mm. (0.23").

Ignition coil.

Starting

Electric starter with electromagnetic ratchet control.

Ring gear bolted on flywheel. Operated by starter button on the right handlebar.

Exhaust system

Dual exhaust pipes and mufflers.

TRANSMISSION

Clutch

Twin driven plates, dry type, flywheel driven. Controlled by lever on the left handlebar.

Gear box

Five speeds, frontal engagement. Helical constant mesh gears. Cush drive incorporated.

Separate case bolted on crankcase, operated by rocker pedal from the R/H or L/H side of the machine.

Engine gear-box ratios: 1 to 1.235 (17-21)

Internal gear ratios:

- low gear 1 to 2 (14-28)
- second gear 1 to 1.388 (18-25)
- third gear 1 to 1.047 (21-22)
- fourth gear 1 to 0.869 (23-20)
- high gear 1 to 0.750 (24-18)

Secondary drive

By constant speed double joint cardan shaft. Layshaft - bevel gear ratio: 1 to 4.625 (8-37)

Overall gear ratios:

- low gear 1 to 11.424
- second gear 1 to 7.929
- third gear 1 to 5.980
- fourth gear 1 to 4.964
- high gear 1 to 4.284

FRAME

Duplex cradle, tubular structure.

Suspension

Telescopic front fork incorporating hydraulic dampers.

Rear swinging fork with externally adjustable springs.

Wheels WM 3/2,15 x 18".

Tires 4.00 x 18 front and rear, block type (Super-sport).

Tire pressure Front tire:

solo
with passenger } 1.5 kgs/sq.cm. = 21 p.s.i.

Rear tire:

solo 1.8 kgs/sq.cm. = 25 p.s.i.
with passenger 2.0 kgs/sq.cm. = 28 p.s.i.

N.B. - The above recommendation is for normal riding (cruising speed). If using the machine at constant high speed or on motorways, the above pressure should be increased by 0.2 kgs/sq.cm. (2.8 p.s.i.).

Brakes Expanding type. 220 mm. dia. (8.66").
Twin leading shoes front brake operated by hand lever on the right handlebar.
Large rear brake operated on left hand side of machine.

Overall dimensions and weight

Wheelbase 1.470 mts. (about 57.8")
Length 2.245 mts. (about 88.3")
Width 0.795 mts. (about 31.3")
Height (dry) 1.050 mts. (about 41.3")
Minimum ground clearance 0.150 mts. (about 5.9")
Curb weight 249 kgs. (about 548 lbs.)

Performances Maximum permissible speeds in each gear, solo riding:

— bottom gear 68 kms/h (42 m.p.h.)
climbability: 86%

— second gear 98 kms/h (61 m.p.h.)
climbability: 46%

— third gear 131 kms/h (82 m.p.h.)
climbability: 28%

— fourth gear 164 kms/h (102 m.p.h.)
climbability: 17%

— high gear 193 kms/h (120 m.p.h.)
climbability: 8,9%

Passing ability

Passing of a 55 feet long truck travelling at 20 m.p.h.

— Time : 6,5 seconds
— Distance travelled: 334 feet

Passing of a 55 feet long truck travelling at 50 m.p.h.

— Time : 8,7 seconds
— Distance travelled: 900 feet

The above includes a safety distance of 40 and 100 feet respectively between the passing and pace vehicle at the beginning and end of the manoeuvre.

Braking ability

Stopping distance from 60 m.p.h. (Solo, using both brakes) : 182 feet

Stopping distance with passenger from 60 m.p.h. (using both brakes) : 198 feet

Fuel and oil capacities

Group or part	Quantity	Recommendation
Fuel tank	22,5 liters (5.84 US gls.)	Petrol 98/100 NO (Regular octane)
Reserve	4 liters (1 US gls.)	
Sump	3 liters (3 ¼ quarts)	
Transmission	0.750 liters (1 ¾ pints)	Shell Spirax H.D. 90
Rear drive box (bevel set lubrication)	0.230 liters (½ pint)	Shell Spirax H.D. 90
Front fork dampers (each leg)	0.160 liters (5.4 oz. US)	Shell Tellus 33

INSTRUMENTS AND CONTROLS

Instrument panel

(See fig. 6)

1. Speedometer.
2. Green light indicating lights on.
3. Red warning light indicating insufficient flow of current from generator for battery charge. Should go out when the engine has reached a certain number of revolutions.
4. Orange neutral indicator. This will light up when the gearbox is either in neutral or in proximity of this position in between 1st and 2nd speed. Under the circumstances, before starting it is well to ensure that the gearbox is effectively in the neutral position but in any case it

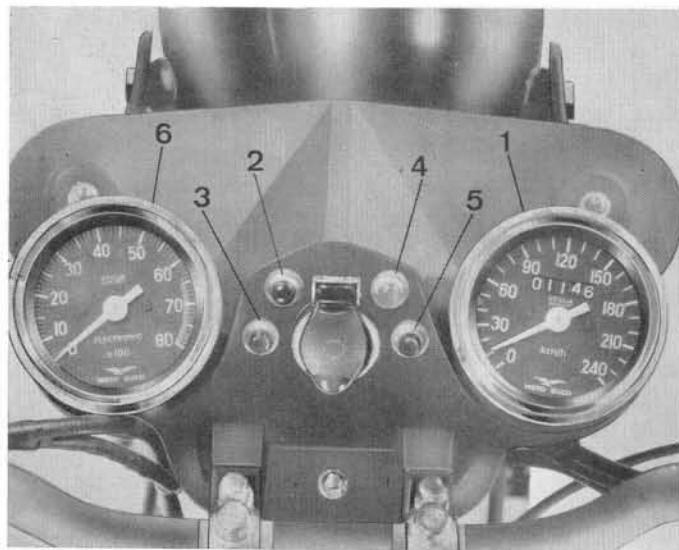

Fig. 6

- is recommended to always start the engine with the clutch disengaged.
5. Red warning light. Oil pressure gauge. Will go out when oil pressure for normal engine operation is sufficient.
6. Revolution counter.

Ignition key (Fig. 7)

This key has 3 positions:
 « 0 » Machine at standstill, key removable, all electrics switched off.

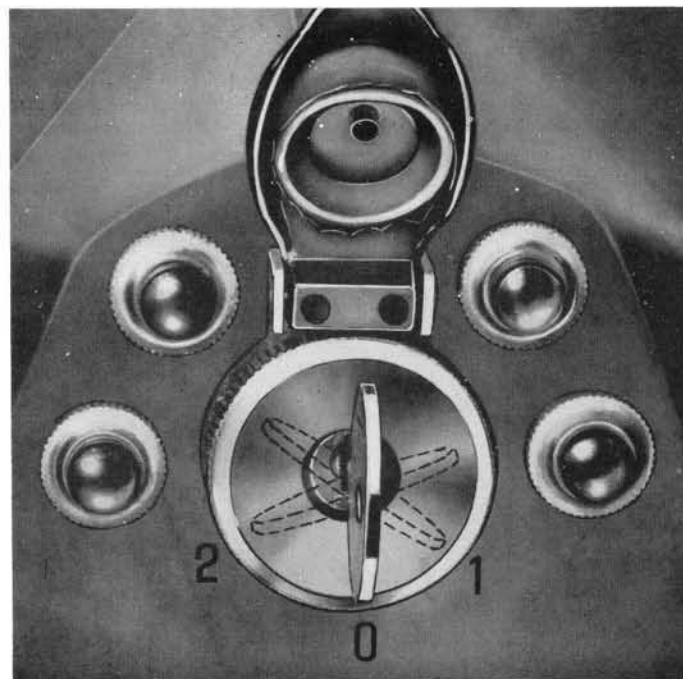

Fig. 7

- « 1 » Machine standing, key removable, parking lights on.
- « 2 » Running position or machine ready to set out. All controls on. For daylight driving no other position necessary. For night driving levers A and B on the left handlebar must be switched on (Fig. 9).

Starting button (Fig. 8)

On right handlebar. With the ignition key in position 2 the machine is ready to be started

Steering lock (Fig. 31)

It is located on the left hand side of the steering column and it is key operated.

Dimmer switch and horn button (See fig. 9)

- It is located on the right handlebar.
- a) position « 0 »: lights off;
 - position « 1 »: parking light (town driving light);
 - position « 2 »: low beam;
 - b) position « 3 »: low beam; / dimmer
 - position « 4 »: high beam; \ switch
 - c) horn button.

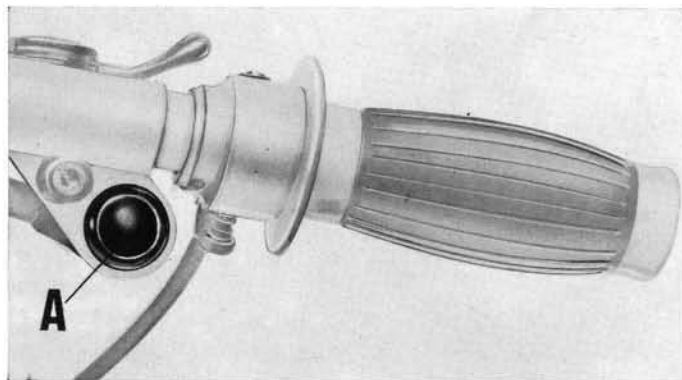

Fig. 8

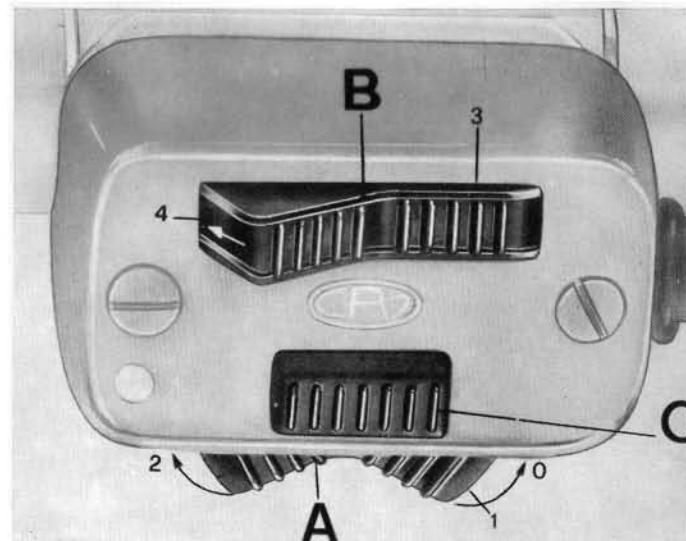

Fig. 9

Clutch lever Is on left handlebar and should be used for starting and gearshifting only.

Twist grip throttle control It is located on the right handlebar. Throttle is opened by turning toward the rider.

Carburetor starter control (Fig. 16) Is on the right hand side of the handlebar. It is opened by pulling toward the rider and viceversa.

Gearshift lever On right hand side of machine.

Front brake lever On right hand side of machine.

Rear brake pedal On left hand side of machine.

Side stand

It is located on the right hand side of the machine and its only purpose is to make parking easier during brief stops. When re-starting make always sure that this stand is returned to the rest position as if it is left inadvertently down, possible serious trouble may ensue.

Turn lights switch

(See fig. 8)

It is located on the right handlebar:
— position « 1 »: right turn lights on;
— position « 2 »: left turn lights on.

RIDING INSTRUCTIONS

Engine starting

Before starting the engine ensure that:

- there is sufficient fuel in the tank
- the oil is at correct level
- the ignition key is on the « 2 » position
- the red warning lights (oil pressure and dynamo charge), and the orange neutral indicator are lit.
- the easy start lever (when starting from cold) is in the open position (See « A » in fig. 16).

When the above has been checked, twist the gas grip 1/4 turn and push the start button on the R/H side of the handlebar. After the engine has started and before returning the easy start lever to its normal riding position (« C » in fig. 16), let the engine idle for a short while in the hot and a few minutes in the cold season to allow the oil to reach all the lubricating points and the cylinders to get warm.

N.B. - Do not forget that the easy starting lever must be returned to the normal riding position. If left open when riding there will be irregular carburation and increased fuel consumption. In some cases there may also be the possibility of seizures due to too much petrol going in the cylinders.

Caution

Do not forget that starting the engine in gear (orange indicator light off) can be very dangerous unless the clutch is kept fully disengaged as with the firing of the engine the machine itself may start off.

Even at low temperatures the machine should always start easily provided everything is in good order and there is sufficient thrust from the starter motor.

If the engine does not start easily, do not

- Maintenance
- △ «SHELL Super 100 Multigrade»
- «SHELL Spirax HD 90»
- ◇ «SHELL Alvania Grease 2»
- «SHELL Tellus 33»

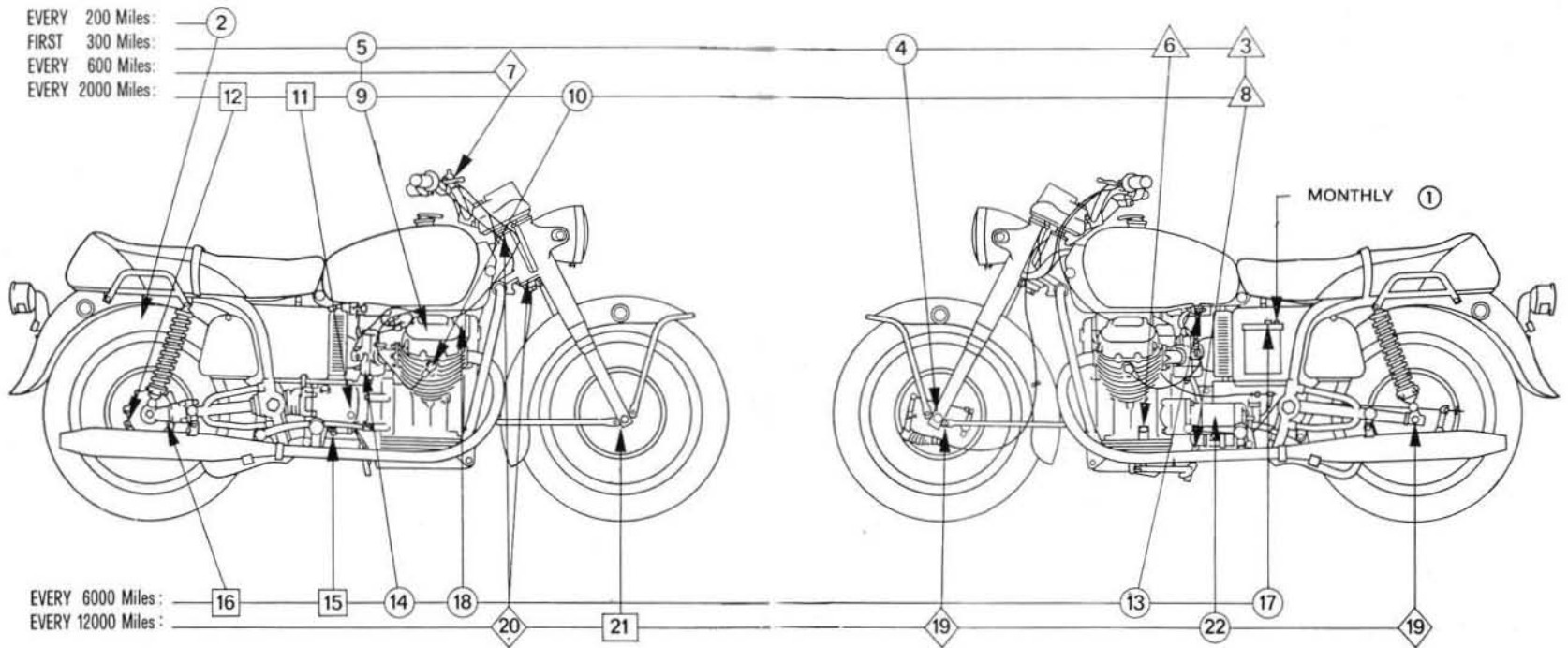

Fig. 11

persist in many attempts but check carburation, ignition, battery charge and if the oil in the sump is of correct gradation.

Starting a hot engine

When starting a hot engine there is no need to open the starter lever as this would richen the mixture and make starting difficult. If starting a hot engine gives some difficulty it is well to open the throttle completely before pushing in the starter button.

Getting under way and stopping of machine

Pull the clutch lever completely, engage low gear, release the clutch slowly, and at the same time turn the gas on.

As soon as the engine has picked up some speed, close the gas, pull the clutch and by downward toe pressure engage second gear. Then release the clutch rapidly (but not with a jerk) and turn on the gas once more. Third and fourth and high gear are likewise engaged by toe pressure.

On the way

In normal riding conditions, all the tell-tale lights should be off, except naturally the red light when riding with the high beam on. If any one of them lights up, this means there is some fault in the system or oil pressure is insufficient.

The maximum speeds in each gear should never be exceeded, not even on steep downhill grades. Do not forget that either with right or left gear shift, by toe pressure you pass to a higher gear and by heel pressure to a lower gear (Fig. 10). Before any gear is engaged, make sure the clutch is completely disengaged. It is necessary to fully close the gas when you change up but it can only

be closed partially when changing down. To obtain fast and effortless gear shifts, always, depress the pedal firmly but gently without stamping or jabbing vigorously on it.

The free position (neutral) is in between first and second gear. To locate this position it is necessary to shift to low gear and then by slight (toe) pressure (half stroke) to feel for neutral position.

With the machine standing still and the engine running, the transmission should always be kept in neutral. Do not keep the clutch lever depressed, even during the briefest stops. Always change to a higher gear rather than let the engine race.

Stopping the machine

As soon as the machine stops, close the throttle, shift to neutral, turn the key to the « 0 » position and take it off (Fig. 7).

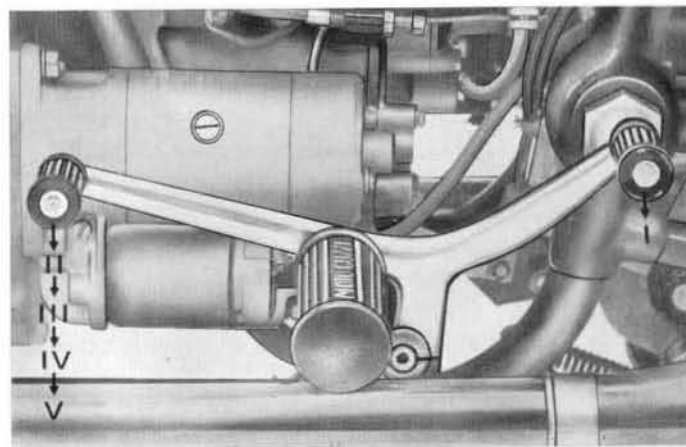

Fig. 10

LUBRICATION AND GENERAL MAINTENANCE CHART

(See fig. 11)

Monthly

- 1) Check electrolyte level in battery (every 15 days in summer). See «Battery».

Periodically

- 2) Check tire pressure with a gauge. See «Tyres» page 16.

After the first 300 miles

- 3) Replace the crankcase oil. See «Engine lubrication».
- 4) Tighten all nuts and bolts.
- 5) Check and adjust tappet play, if necessary. See «Tappet adjustment».
- 6) Check and if necessary top up oil level in crankcase. Correct oil level is in between the minimum and maximum marks on the dipstick. See «Engine lubrication».

Every 600 miles

- 7) Lubricate cable ends. See «Lubrication of clutch, front brake and air cables».

Every 1800 miles

- 8) Replace oil in crankcase. See «Engine lubrication».
- 9) Check tappet clearance. See «Tappet clearance».
- 10) Check and clean spark plugs. See «Spark plugs».
- 11) Check oil level in gear box and if necessary top up. See «Lubrication of gear box».
- 12) Check oil level in transmission box for lubricating bevel gears. If necessary, top up.

Every 6000 miles

- 13) Clean petrol taps and filters, carburetor filters, and fuel line to carburetors. See «Carburation».
- 14) Strip carburetor and check all parts. Use an air jet to clean out all ducts. See «Carburation».
- 15) Change gear box oil. See «Lubrication of transmission».
- 16) Change rear drive box oil. See «Lubrication of rear drive box».

After the first 12.000 miles

- 17) Check cleanliness and tightness of all battery connections and smear them with vaseline. See «Battery».
- 18) Clean commutator of generator using a clean cloth slightly moistened in petrol. See «Generator».
- 19) Check condition of wheel bearings and pack them with grease. See «Lubrication of wheel bearings».
- 20) Check condition of steering bearings and pack with grease.
- 21) Replace oil in inner tubes. See «Lubrication of fork».
- 22) Clean starter motor commutator using a clean rag slightly moistened with petrol.

SERVICING INSTRUCTIONS

Lubrication of engine (See fig. 12)

Using the oil filler dipstick (A), check the sump level every 500 kms. (300 miles).

Correct oil level is in between the minimum and maximum marks. Make this check on a warm engine with the filler cap screwed on one turn.

Every 300 kms. (1800 miles) change the engine oil (on a new or overhauled machine this change should be made after the first 500 kms. (300 miles). The oil should be replaced when the engine is warm by un-

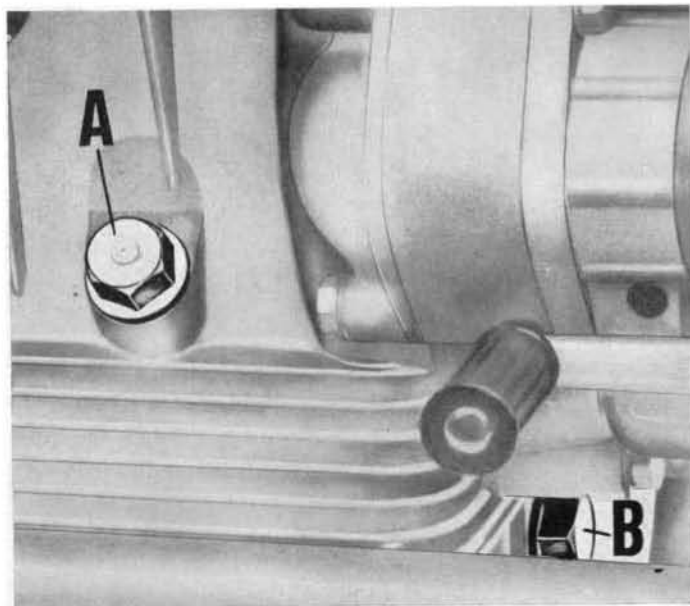

Fig. 12

screwing filler cap (A) and drain plug (B). Allow all the old oil to drain, re-fit plug B, and introduce fresh oil. Quantity required: about 3 liters (3³/₄ quarts). Oil recommendation: SHELL Super 100 Multigrade or an equivalent.

Oil pressure relief valve

Under no circumstances should this valve be tampered with as it has already been calibrated at the factory for a pressure operation of 3.8 - 4.2 kgs./sq.cm. (54 - 60 lbs. sq.in.).

Oil pressure gauge

The indicator light goes out when the pressure is sufficient to open the contact of the pressure operated solenoid.

If this light stays lit, then the oil pressure is incorrect. In such cases, stop the engine

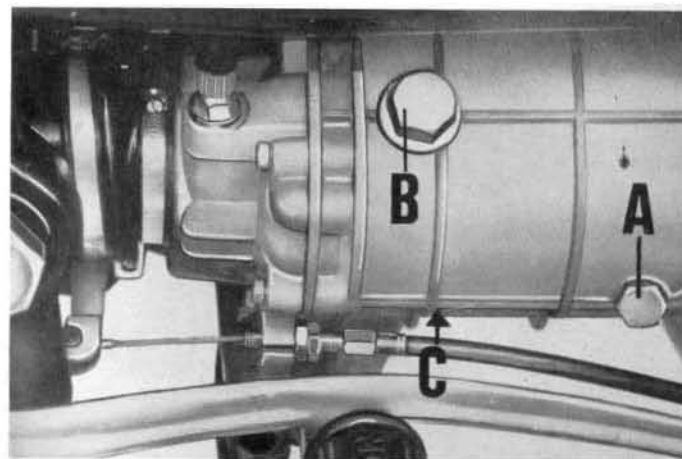

Fig. 13

and inspect all passages and oil lines to determine the cause and correct it before re-starting.

Lubrication of transmission
(See fig. 13)

The oil in this box must be checked every 3000 kms. (1800 miles). The level is correct when the oil is flush with plug hole (A). Change this oil every 10.000 kms. (6000 miles). This operation should be carried out a short time after a ride when the oil is warm and easily drained.

To change the oil proceed as follows: unscrew filler cap B, level plug A and drain plug C under the box. When the old oil has drained and plug C re-fitted, introduce fresh oil through B until it starts to leak out from level hole A, when both plugs can be put back.

Oil quantity required: abt. 0.750 liter (1¾ pints).

Oil recommendation: Shell Spirax 90 HD or an equivalent.

Lubrication of rear wheel drive
(See fig. 14)

The oil level of this box should be checked every 300 kms. (1800 miles).

The oil should just skim hole A. Change the oil every 10.000 kms. (6000 miles) and do this operation on a hot engine. Unscrew filler plug B, level plug A, and bottom drain cover screws C.

When the old oil has drained, refit the cover and introduce new oil until it starts seeping through hole A, finally screwing on plug A. Quantity required: about 0.230 liters (½ pint).

Oil recommendation: Shell Spiral 90 HD or equivalent.

Lubrication of front fork and hydraulic dampers
(See fig. 15)

Every 20.000 kms. (12.000 miles) or earlier, if necessary, change the oil in the fork tubes. Proceed as follows: remove the drain plugs and washer (A) and plugs (B). When the oil has drained, and drain plug A screwed on, introduce fresh oil through B.

Quantity of oil required for each fork tube: about 0.160 liters (5,4 oz.). Oil recommendation: Shell Tellus 33 or equivalent.

Lubrication of bevels in the steering

Every 20.000 kms. (12.000 miles) check condition of these bearings and pack them with Shell Alvania grease 2 or an equivalent.

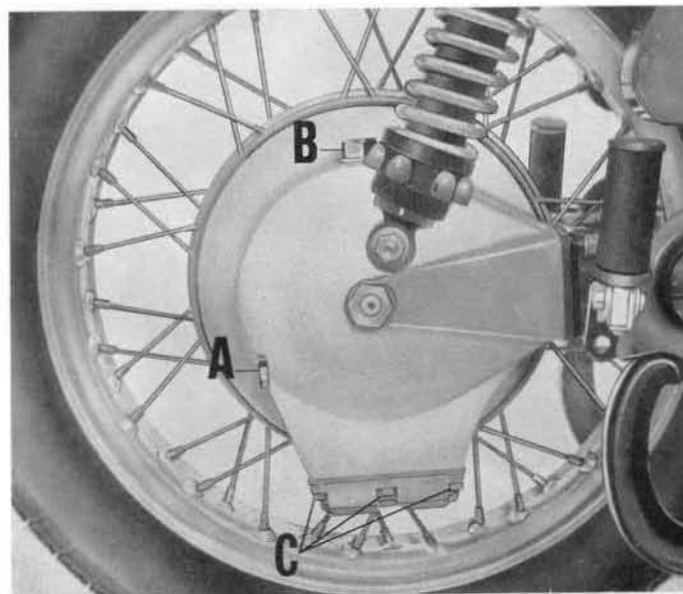

Fig. 14

**Lubrication of
wheel bearings**

Every 20.000 kms. (12.000 miles) check the condition of these bearings and pack with Shell Alvania Grease 2 or an equivalent.

**Lubrication of
control cables**

Every 100 kms. (600 miles) clean the cable ends and lubricate with Shell Alvania grease F2 or an equivalent. Actuate the levers several times to allow some of the grease to enter into the casings.

**Lubrication of
rear fork
bearings**

At the time of a general overhaul it is well to inspect these bearings to ensure that they are still efficient and, if necessary, pack them with grease. Recommended lubricant: Shell Alvania grease 2 or an equivalent.

**Oil breather
unit**

If the motorcycle is left unused for any considerable length of time there is the possibility that foreign matter eventually present in the oil may deposit on the diaphragm inside the breather causing this to get stuck with consequent oil leakages.

Under the circumstances, we recommend to inspect this unit before using the machine again and this can be done by removing the unit from the machine with the fuel tank assembled.

Proceed as follows:

- Unscrew the breather unit securing bolt.
- Back out the breather from the left.
- Check that the pressure relief valve inside the breather can move freely. This can easily be done by means of a suitable rod introduced in the central tube of the breather. If the valve is stuck, free it with



Fig. 15

the rod and wash the tube out first with pure petrol and then with an oil-petrol mixture. Finally dry off with an air jet to prevent the valve from oxidizing and getting stuck again to the tube end from the engine.

The unit can now be re-assembled on the machine.

CARBURATION

Carburetor

This model is fitted with 2 dual control Dell'Orto carburetors type VHB 29 CD on the right and VHB 29 CS on the left.

Both controls are on the right handlebar: one is the easy starting lever for cold starts, the other is the throttle twist grip control. When starting a cold engine, the easy start lever is turned on the open position « A » (See fig. 16).

After the engine has warmed up — a few seconds in the summer and a few minutes in winter, — this lever must be returned to the normal riding position « C » in fig. 16.

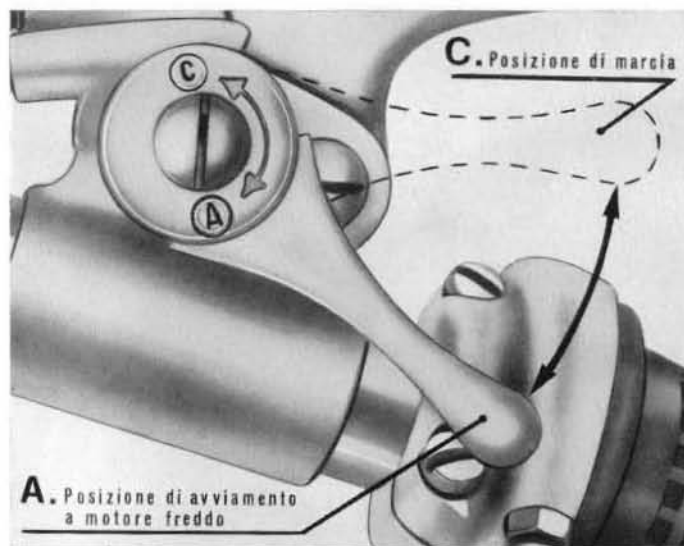

Fig. 16

Standard carburetor setting

Choke	: 29 mm.
Throttle slide	: 60
Atomizer	: 265
Main jet	: 145
Idling jet	: 45
Easy start atomizer	: 80
Needle jet	: SV 5 (2nd notch from top)

Idling screw open $1\frac{1}{2}$ to 2 turns for the left carburetor and 2 to $2\frac{1}{2}$ turns for the right carburetor.

Adjusting the carburation

The carburation is adjusted on a hot engine after the inlet and exhaust tappets have been set at the correct distance.

Proceed as follows:

- 1) Ensure that the easy starting lever in its fully closed position has about 4 mm. (.16") end play as if the cable is too stretched engine vibration may cause the valves on the carburetors to open with a consequent irregular carburation.
- 2) With the filter box and the rubber inlet manifold removed, check that both gas valves open at the same time. This is done by turning the throttle grip and at the same time feeling with your fingers on the carburetor slides if these open simultaneously by the same amount. Should one valve open before the other, correct by setting screw A (See fig. 17) in the position where by turning the throttle both valves open simultaneously.
- 3) Adjust the idling speed by acting on screw C in fig. 17. Screwing this in reduces the fuel flow and viceversa increases it. To adjust, tighten the screw and then undo it $1\frac{1}{2}$ -2 turns for the left cylinder carburetor and 2- $2\frac{1}{2}$ turns for the right cy-

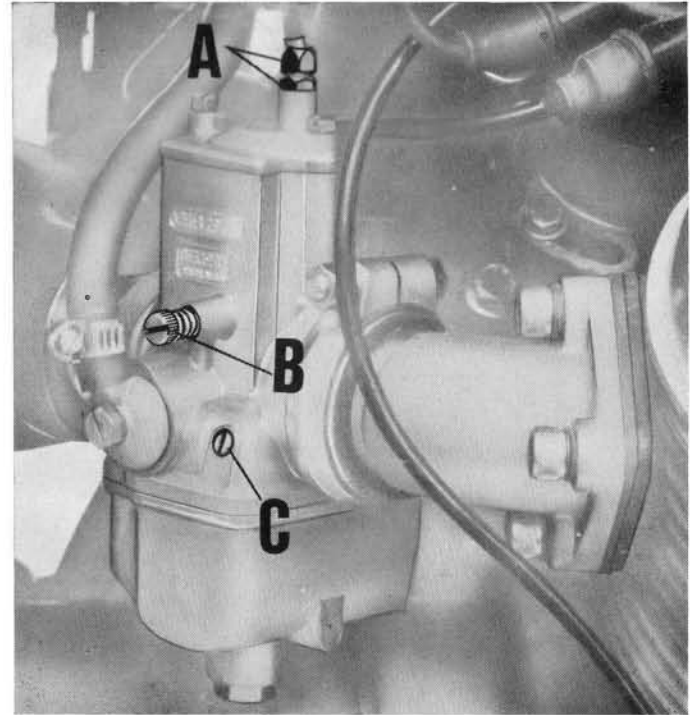

Fig. 17

linder carburetor. With the engine revolving at about 1000-1200 r.p.m., disconnect the plug lead of any one of the cylinders and lightly turn screw C in fig. 17 of the opposite carburetor on to the position which will give the best idling speed, i.e. until the engine revs increase slightly. The same operation should be repeated

on the carburetor of the opposite cylinder. This will give a correct idling speed and prevent engine popping.

Engine speed: Due to the constructive characteristics of this engine, the idling speed adjustment should never be made with the engine running at less than 800-900 r.p.m.

A good idling speed is obtained as follows:

- 4) Disconnect the R/H cylinder plug lead, start the engine, and ensure that it stops after firing 4 or 5 strokes. If it dies out earlier or later, it is necessary to adjust idling screw B in fig. 17 to the point where the engine will stop after firing 4 or 5 times.

Repeat the same operation on the R/H cylinder with the L/H cylinder plug lead disconnected.

If the R/H cylinder is normal, the engine should stop after firing 4 or 5 times. If not, screw B in fig. 17 should be similarly adjusted to the position where it does so. The L/H cylinder plug lead is then reconnected.

Stripping of carburetor

(See fig. 18)

Remove:

- Mixture chamber cover (1) complete with cable adjusting nut and spring (2), after loosening screws (3).
- Throttle slide (4) with taper needle (5).
- Throttle slide stop screw and spring (6).
- Plug and washer (7).
- Bowl (8).
- Pilot jet (9).
- Accelerator pump (10) with main jet (11) and atomizer (12).
- Easy start atomizer (13).
- Float (14) with securing pin (15).
- Needle (16).
- Pilot air screw (17) with spring.
- Adaptor screw (18) with washer.
- Adaptor (19).
- Adaptor filter (20).
- Air control plug (21) with screw and nut.
- Plug securing screw (22).
- Spring (23) with air control plug (24).

After the carburetor has been stripped and all parts cleaned with an air jet, it is a good practice to inspect and clean the fuel filters and line from the tank.

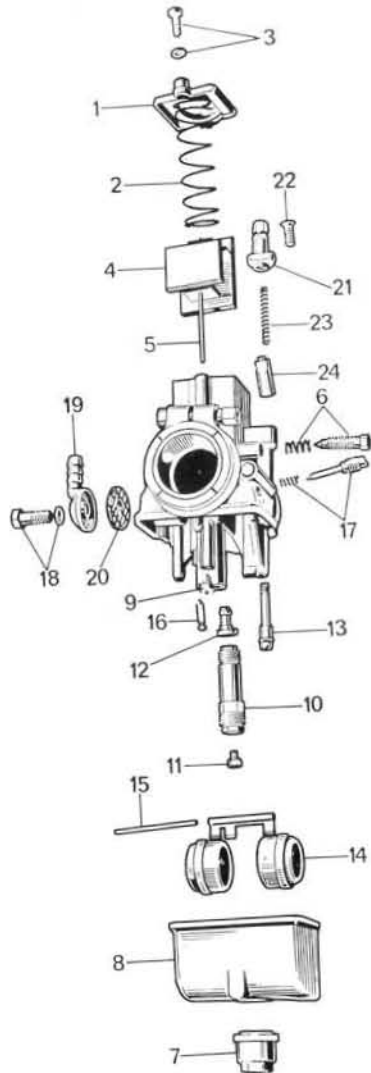

Fig. 18

Air filter
(See fig. 19)

The dry type filter is located in a suitable housing secured to the frame. Air to the carburetors is taken directly through a rubber sleeve from the filter box. When the filter is too dirty, replace it with original equipment.

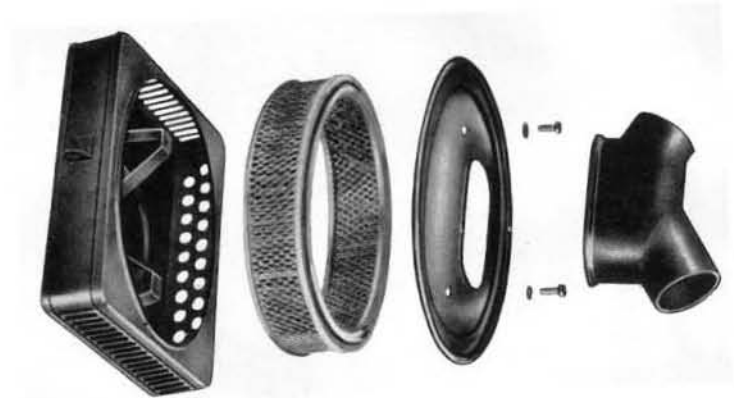

Fig. 19

CLEANING OPERATIONS

Filter and fuel lines (See fig. 20)

Every 10.000 kms. or so (6000 miles) or any time fuel flow to the carburetors is not regular, it is necessary to check if there are no leakages at the fuel line connections (See C fig. 20) or if the filter on the taps (A) and the carburetors (B) are clean.

If the filters are obstructed, clean them in a petrol bath and dry off with compressed air.

If the plastic lines have got too hard at their connecting ends, replace them with original equipment.

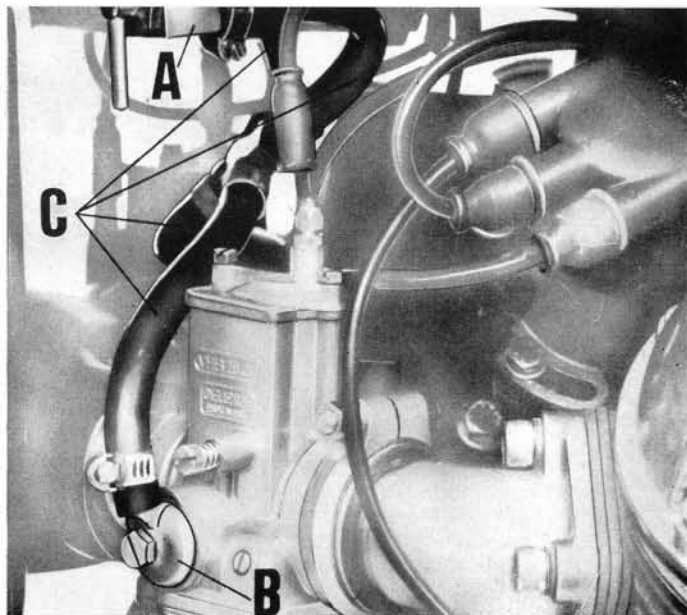

Fig. 20

Fuel tank

When overhauling the carburetors it is well to clean the fuel tank as well. The tank is best cleaned when detached from the vehicle. Pour some petrol in it and shake vigorously. Then drain it from the filler cap hole to carry away any sludge or scaling which may have deposited at the bottom of the tank.

Fuel taps (See fig. 21)

Are located under the fuel tank and are open when turned downwards (See A) and closed when in the horizontal position B. It is a good practice to keep one tap only open and to use the other as a reserve tap in an emergency.

This tap should occasionally be checked to ensure it is not obstructed.

Mufflers

Internal cleaning is carried out by filling them with a solution of boiling water and caustic soda (20%) and leaving them to stay for about 1 hour. The mufflers are then emptied and rinsed out with boiling water while shaking vigorously.

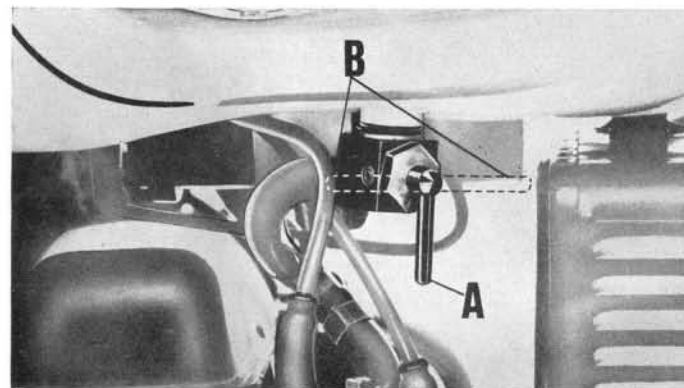

Fig. 21

**Cylinder heads,
piston and valves**

Every 10.000 kms. (6000 miles) the cylinder head should be removed for decarbonizing. The combustion chamber and piston crowns are best cleaned with a blunt scraper and a wire brush and washed off with petrol. Check that the valve seats are properly sealed by pouring some petrol through the inlet and exhaust ducts and observing if any seeps through between seats and valves. If so, the valves should be dismantled and the seats ground in with emery paste. At the end of this operation the head and

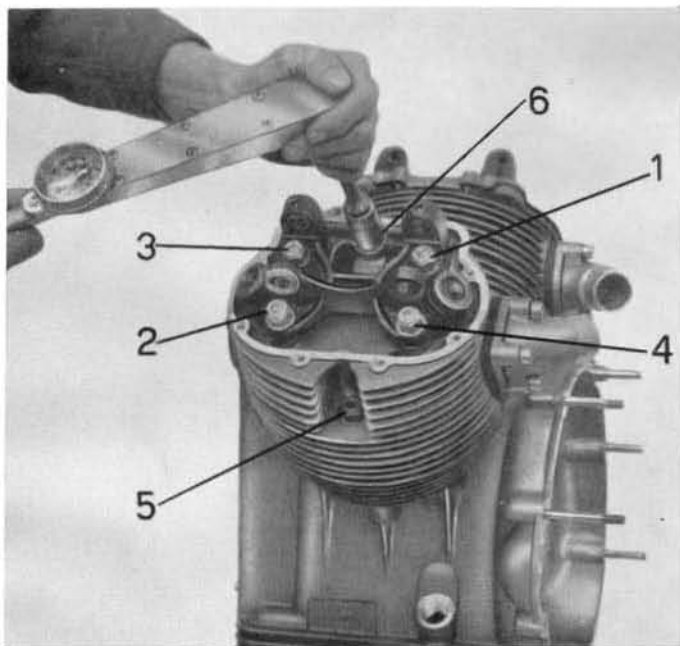

Fig. 22

valves should be thoroughly cleaned with petrol and compressed air to remove all traces of the abrasive.

When re-assembling the heads the nuts and hold down studs should be tightened in a crossed sequence (See 1-2-3-4-5-6 in fig. 22) using a torque wrench set at 3,800 Kg/m (27 ft. lbs.).

VALVE GEARING

Tappet clearance
(See fig. 23)

Every 3000 kms. (1800 miles) or any time valve operation is too noisy, check tappet clearance.

This adjustment is made on a cold engine with the piston at TDC and both valves closed while the piston is on its maximum compression stroke.

Using the wrench supplied in the tool kit, undo nut A and screw in or out screw B.

Correct clearance is:

- Inlet valve 0.15 mm. (.0059")
- Exhaust valve 0.25 mm. (.0098")

Use a feeler gauge (C) to check this clearance. When this is excessive, there will be noisy valve operation.

If it is less, the valves may not close fully causing compression loss, overheating of the engine, etc.

On a new engine, this adjustment must be made after the first 500 kms. (300 miles).

Checking valve timing

The engine is timed when the gears are set as shown at A and B in fig. 24. A proper check of valve timing is always done better in any officially appointed Moto Guzzi dealer shop.

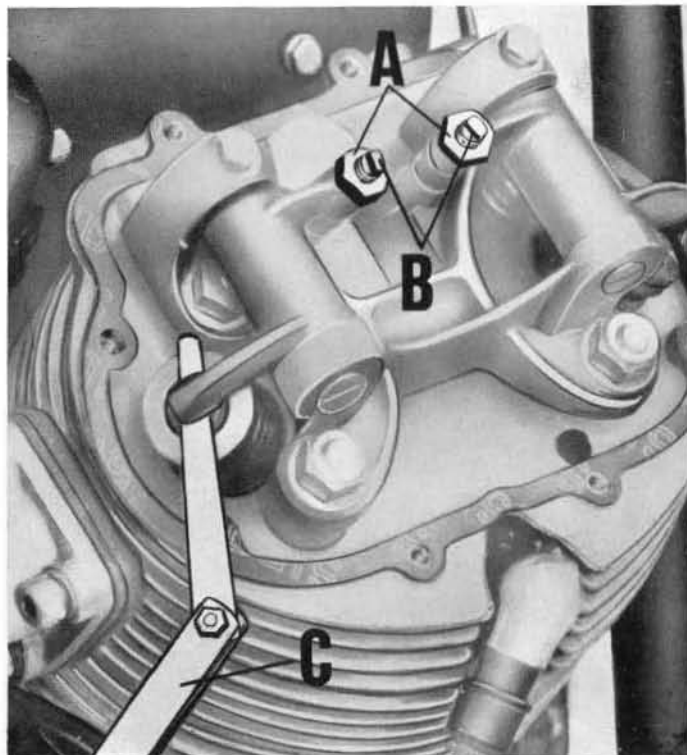

Fig. 23

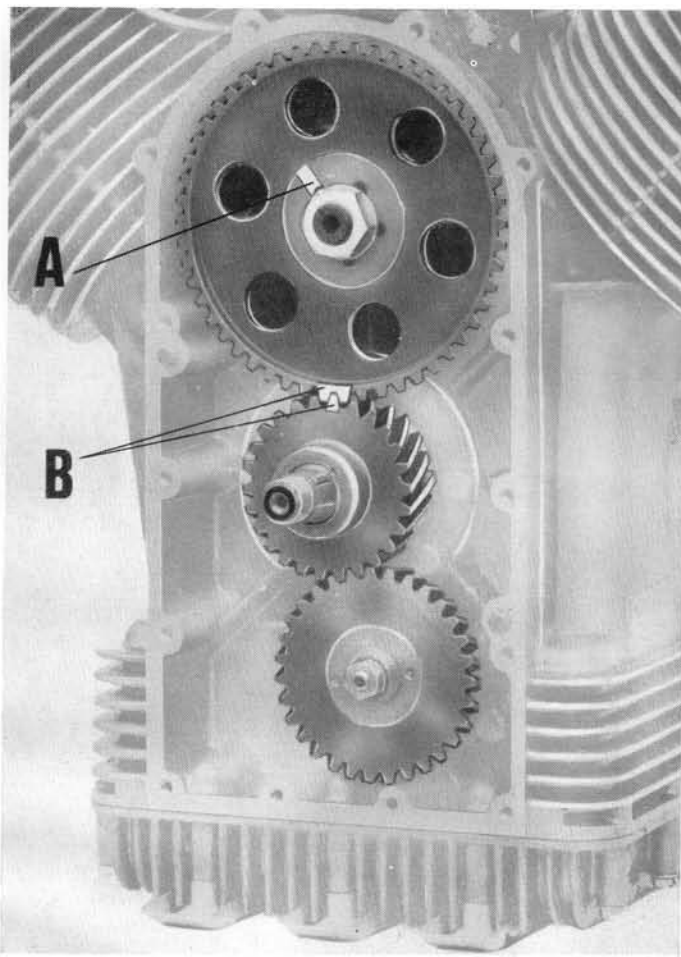

Fig. 24

IGNITION

Distributor (See fig. 25)

Every 3000 kms. (about 1800 miles) the cam felt pad should be lubricated with a few drops of oil and the contact points inspected to ensure they are clean. If dirty or greasy, clean them with a petrol soaked cloth. Correct gap is 0.42 - 0.48 mm. (.016-.018"). If they need adjusting, loosen screw B which secures the fixed contact plate and move this to the position which will give the correct gap. However, the contact points should be changed whenever it is necessary.

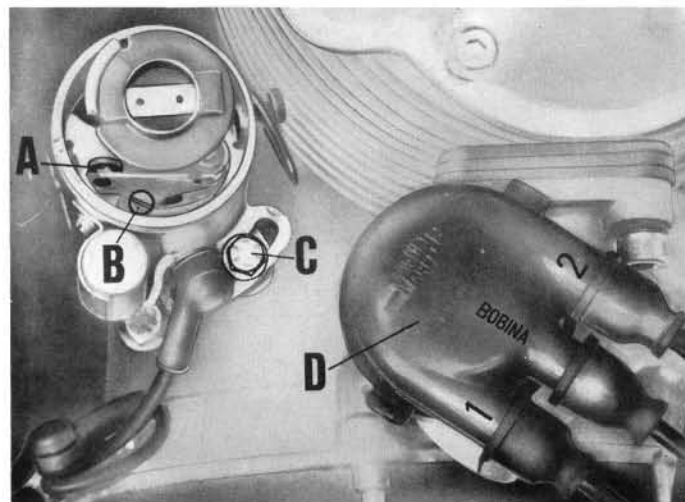

Fig. 25

Spark plugs

Every 3000 kms. (1800 miles) check the gap which should be 0.6 mm. (.023"). Check also the high tension leads and replace, if necessary. The spark plugs are best cleaned with petrol, a wire brush, and a needle for the inner part.

In fitting the plugs, make sure they are started by hand for a few turns and to complete the operation by means of the plug wrench in the tool kit. Do not overtighten to prevent stripping of the thread.

Checking of ignition timing

Remove generator belt cover. Check that the distributor contact points are 0.42-0.48 mm. (.016"-.018") apart. Ensure the left cylinder (2) is on its compression stroke i.e. with both valves closed. Rotate the generator pulley on the crankshaft till the slot C (see fig. 26) is opposite mark A traced on the timing cover.

In this position the points should start to open and to ensure that they do so use a timing light which will light up at the exact time the points start opening.

If the points start to open before or after the mentioned point, slacken distributor securing bolt C (fig. 25) and turn the distributor to the right or left to the position where the points start opening at the proper time.

The cylinder number is marked on the distributor cap as follows: n. 1 (right cylinder), n. 2 (left cylinder), « bobina » = coil (See D in fig. 25).

Checking of ignition advance (fixed and automatic) by means of a stroboscope lamp

For checking the ignition advance, the crankshaft driven generator pulley of the V-7 engines has been provided now with 3 additional timing marks. When in coincidence with arrow « A » already stamped on the timing cover, these marks will serve to determine if the ignition is correctly timed.

The new reference marks on the pulley (See fig. 26 and diagram 27) can be defined as follows:

- « B » (first on the left) is the TDC position mark for the 2nd cylinder (on the left, as seen astride the saddle).
- « C » is the 5° fixed advance position to the TDC.
- « D » is the 25° automatic advance position to the TDC.
- « E » is the 33° maximum advance position (fixed + automatic) to the TDC.

With the engine assembled on the machine, this control is made as follows:

- Remove generator belt cover by unscrewing its 3 retaining bolts.
- Connect the timing device cable to the plug of cylinder 2 (left sitting in the saddle).
- Connect the 2 stroboscope cables with clamps to a battery, ensuring that clamp (+) is secured to battery pole (+) and the other to pole (—).

After these connections to the plug and battery have been made, start the engine and direct the stroboscope light on to arrow « A » on the timing cover.

Check that this arrow coincides with the generator pulley marks « C-D-E » at the following engine speeds:

- Mark « C » at 1200 ± 100 r.p.m.
- Mark « D » at 2200 ± 100 r.p.m.
- Mark « E » at 3600 ± 100 r.p.m.

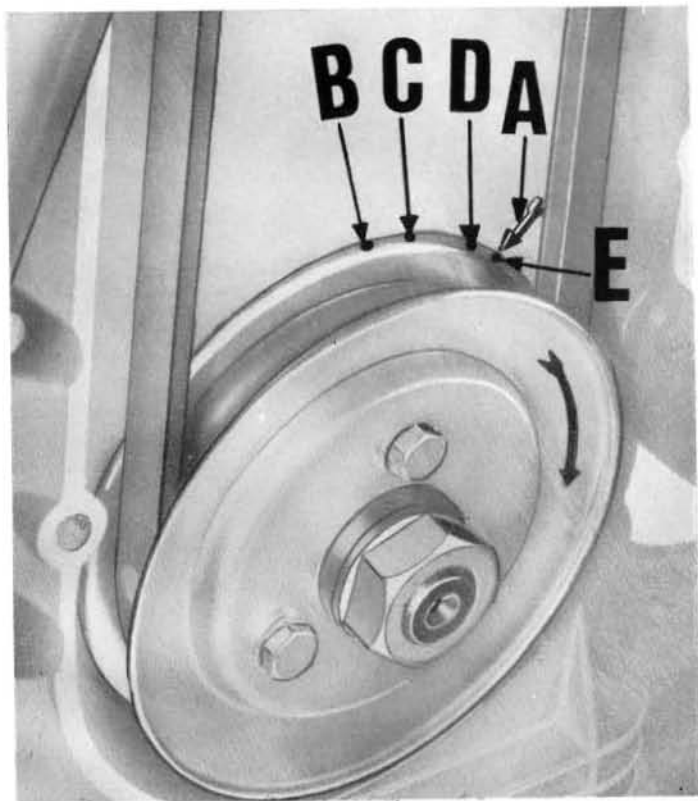

Fig. 26

If this check shows that arrow « A » is in coincidence with pulley marks « C-D-E » at the above engine speeds, then the fixed and automatic advance are quite normal.

IGNITION CHART

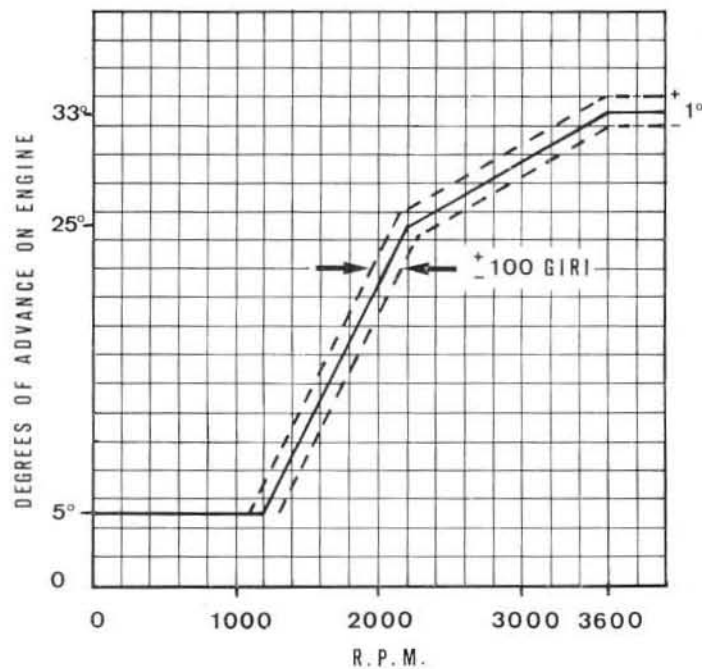

Fig. 27

ADJUSTMENTS

Generator belt (See fig. 28)

After long service the belt may slacken and in such case it should be tensioned. Normal belt slack A is 1 cm. per 10 kgs. (.39"/21 lbs.). The belt is tightened as follow:

- Unscrew bolts B which secure the outer half-pulley to the hub,
- remove the external half pulley,
- remove one or more spacing collars to reduce the width of the race,
- if it is necessary to remove more than one spacer, they should be placed at the front and rear of the pulley.

Finally, re-fit the outer half-pulley, tightening its 3 securing bolts (B).

Clutch lever (See fig. 29)

This lever should be adjusted when the free play at the handlebar is more or less than 4 mm. (1/8"). Slacken thumb screw B and screw in or out adjuster A to obtain the correct distance. Don't forget to re-lock thumb screw B.

If the distance is less, the clutch may slip causing the plates to wear out. If it is more, there may be incomplete disengagement of the clutch and consequent noisy gearshifting. This adjustment can also be carried out by slackening nut D and acting on adjuster C bolted on the battery bracket.

Steering (See fig. 30)

Looseness of the steering is remedied as follows:

Slacken locknut A and using a suitable wrench, adjust locking B to the position which will take up excessive play and then re-lock nut A by keeping a hold on locking A.

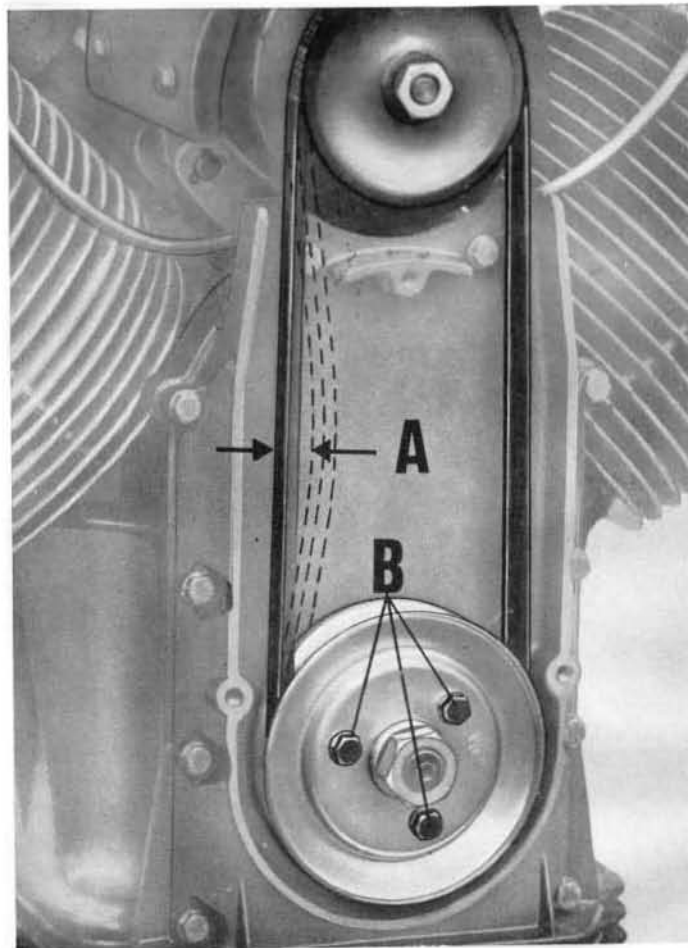

Fig. 28

N.B. - Do not forget that loose steering may cause wear of the taper bearings.

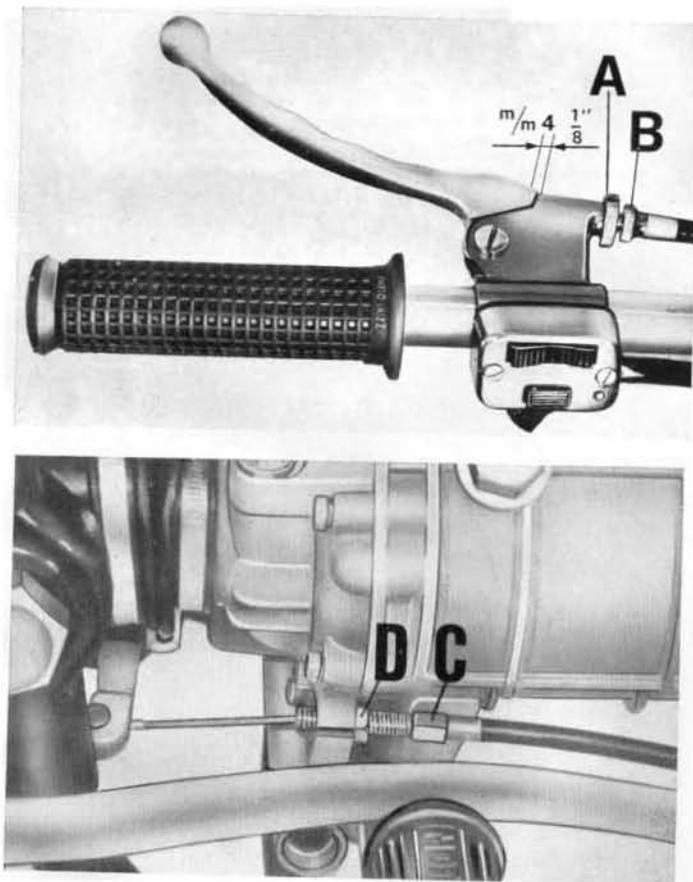

Fig. 29

Steering lock (See fig. 31)

It is located on the L/H side of the steering column (See A) and it is key operated.

To lock: turn the handlebar completely to the right and insert the key turning it forward (toward the front wheel). Push it in, release it, and pull it out.

To open: insert key in the lock, turn it forward, and release it.

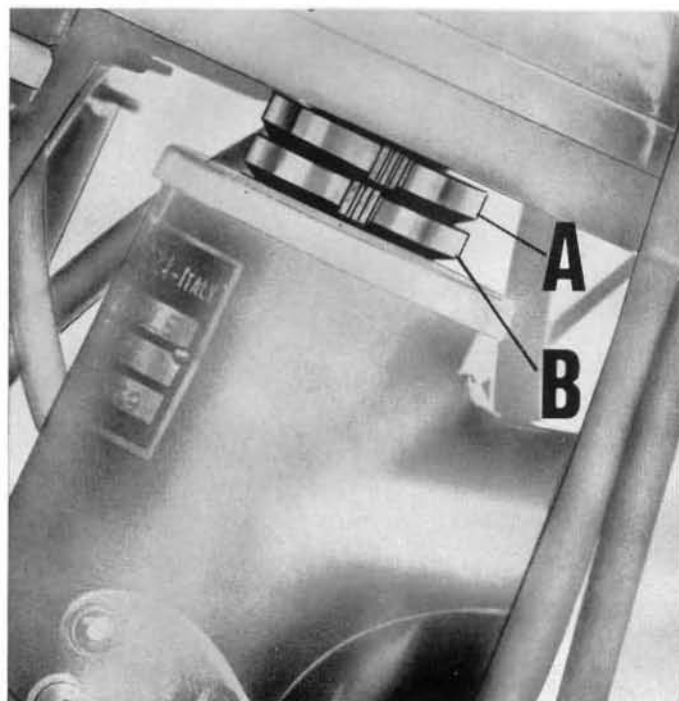

Fig. 30

Front brake lever

(Fig. 32)

Play at the handlebar lever should be checked periodically. The lever is adjusted when there is about 20-25 mm. ($\frac{3}{4}$ to 1") play at the handlebar before the linings contact the drums.

Excessive play is corrected by acting on thumb screw B and adjuster A or on adjuster C and nut D on the hub cover.

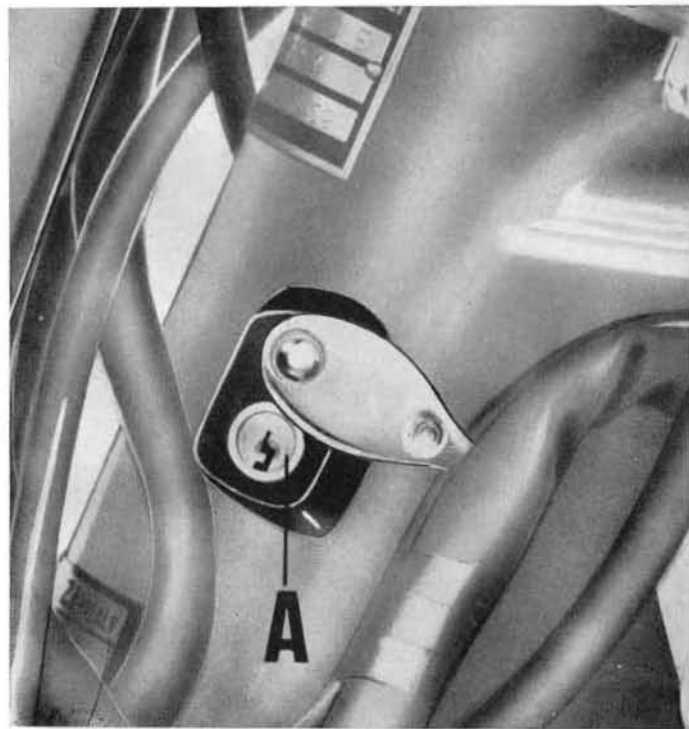

Fig. 31

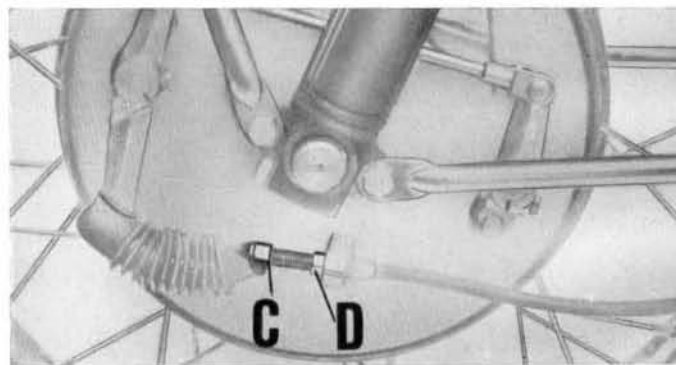
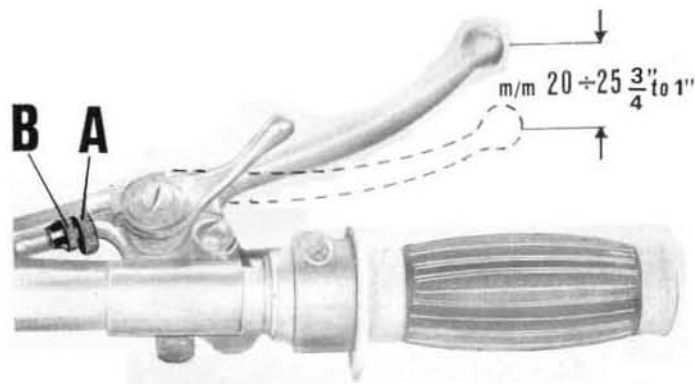

Fig. 32

Rear brake pedal
(See fig. 33)

Adjustment of this lever is made by means of the thumb screw fitted on the threaded portion of the brake rod.

Excessive play is corrected by screwing in thumb screw A on the rod until there is a play of about 20-25 mm. ($\frac{3}{4}$ to 1") at pedal B before the linings contact the drums.

Generally, when the screw is fully screwed on it means that the lining is completely worn out and has to be changed.

Rear suspension units
(See fig. 34)

The rear suspension unit has a 3-position adjustment: I for normal load, II medium load, III heavy load.

Change over to any required position is made by turning knob B using the special wrench

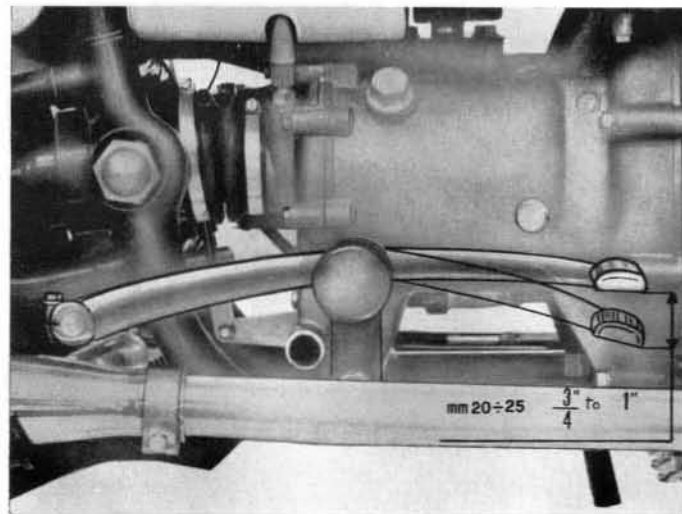

Fig. 33

(A) in the tool kit. This knob is turned anticlockwise until «II» or «III» coincides with reference C.

In case of faulty damper operation it is recommended to have them checked by your dealer or in a shop officially appointed by the makers.

Checking the gear operating mechanism
(See fig. 35)

In case of noisy gear shift, it is well to check and adjust the operating quadrant which drives the selector drum.

This is done by loosening lock nut B and

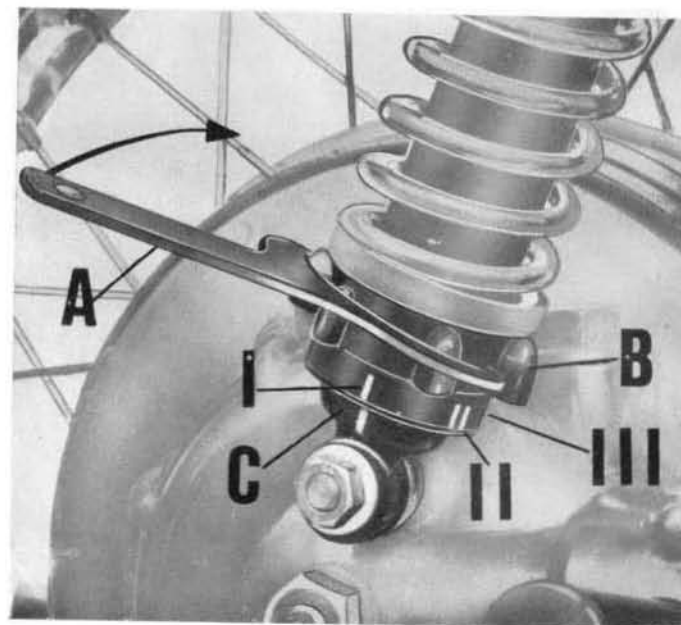

Fig. 34

screwing in or out the eccentric A in fig. 35 to find the position where it is felt that by changing up and down all gears engage smoothly and the free position is easily selected. Locknut B is then re-tightened keeping a fast hold on screw A.

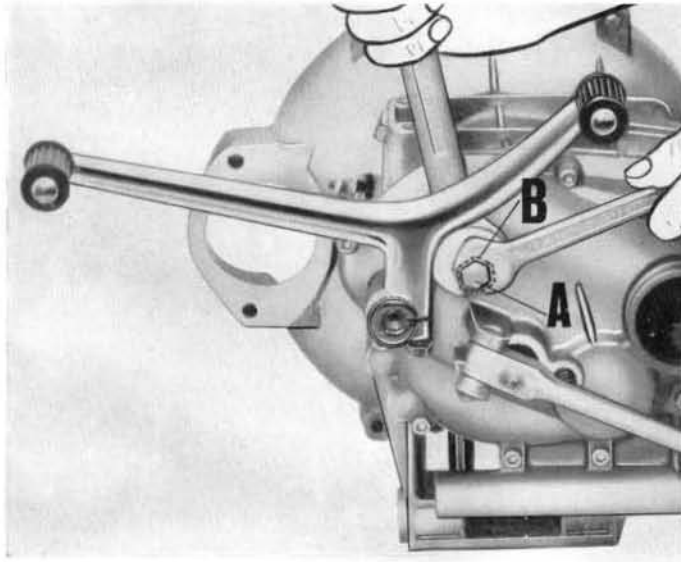

Fig. 35

REMOVAL OF WHEELS

Front wheel
 (See fig. 36)

To remove the front wheel disconnect the front brake cable from the operating lever on hub cover and unscrew cable adjuster B. Undo nut « C » which secures the wheel

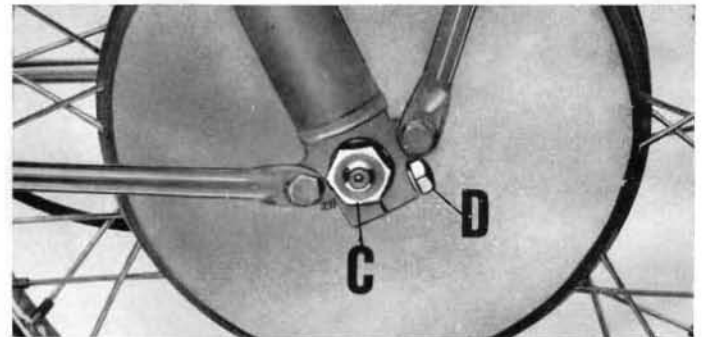
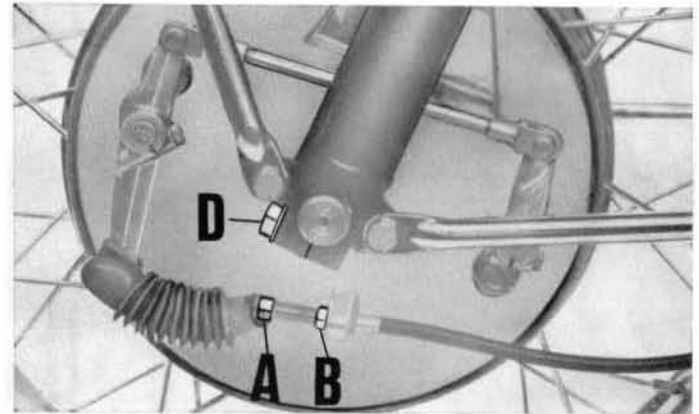

Fig. 36

spindle to the right fork member and bolt B which secures the left hand member, taking out the wheel spindle. Now push the wheel down just sufficiently to free the brake block from its anchoring lug on the left fork member and back it out.

N.B. - When re-assembling dont forget to insert the brake block in its anchorage on the left fork member.

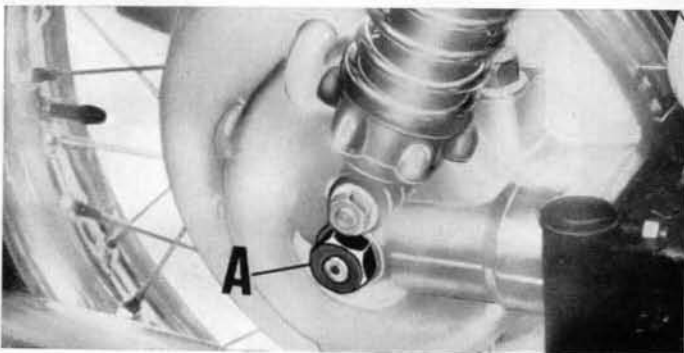
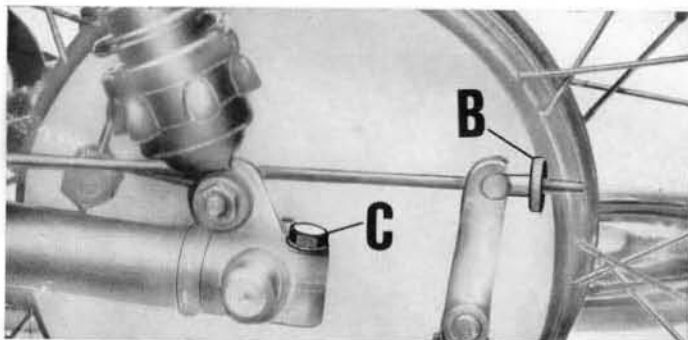

Fig. 37

Rear wheel (See fig. 37)

Unscrew nut A which secures the wheel spindle to the rear drive box and the nut which secures the stay to the brake block. Undo the rear brake adjusting thumb screw (B) and bolt C which locks the spindle to the rear fork and withdraw the spindle.

Pushing the wheel to the left will free the wheel from the sleeve in the drive box thus allowing the wheel to be removed by leaning the machine sideways.

N.B. - When re-assembling dont forget to secure the anchoring brace to the brake block.

ELECTRICAL EQUIPMENT

(See diagram in fig. 38)

Battery

The 12 V battery is centrally mounted and has a capacity of 32 Ah. It is charged directly by the generator.

Every month or earlier in the hot season check the electrolyte level in each cell and if necessary top up with distilled water, using a glass or plastic funnel. The level is correct when the acid tops the plate separator by about 6 mm. (1/4"). Always top up with distilled water and not with sulphuric acid.

Add distilled water to a cold battery after it has not been in use for at least 6 hours.

Make sure that no electrolyte flows over the top of the battery which must always be in a perfectly dry condition. If the level in any one cell is lower than in others, this may be due to either cracks or other faults and in such case the battery should be immediately replaced.

Every 6000 miles check that all battery connections are in a perfectly clean condition and smear them with vaseline to prevent oxidation.

The battery is charged when the hydrometer reading shows about 1.28 sp.g. for normal service and about 1.23 sp.g. for service in tropical conditions. An almost discharged battery shows a reading of about 1.16 sp.g. for normal service and about 1.1 sp.g. for tropical conditions.

Putting the dry charged battery in service

1. Break off the seal and unscrew the plug.
2. Introduce pure sulphuric acid of 1275 sp.g. - temperature 15" (31" Baumé).

This operation has to be carried out very carefully and particular attention should be paid to the specific gravity of the recommended liquid.

The correct electrolyte level is 6 mm. over the plate separators (.23").

3. Let the battery at rest for about 2 hours and then top up with electrolyte to the recommended level.

The battery can now be charged for 8-15 hours at a current intensity equal to 1/10th of its normal amperage (in 10 hours discharge).

4. The battery is now ready to be put in service.

Varta type battery

This brand battery is put in service exactly as said at points 1 and 2 above but point 3 should read as follows:

3. Let the battery at rest for 15 minutes and shake it lightly. Check the electrolyte level and top up as necessary. Screw the plugs on tightly.

At this stage the battery is ready to be installed on the motorcycles and the cables connected.

Maintenance instructions

During the period that the battery is left at rest before use, ensure the electrolyte level is about 6 mm. (.23") over the top of the plate separators. Ensure that this level is maintained at all times with the addition of distilled water. Never add sulphuric acid. If the battery is not used immediately, it is best to have it charged for a short period every month or every time before it is used.

Successive charges

Before re-charging make absolutely certain that the battery is in a perfectly clean condition.

Connect to the charging medium and use preferably an amperage equal to but not exceeding 1/10th of the rated battery capacity over a period of 10 hours.

If during the charge the electrolyte temperature (measured with a thermometer immersed in the electrolyte) should get up to 50°C (122°F), it will be necessary to reduce or interrupt the charge until the temperature has dropped to under 40°C (104°F).

Never add sulphuric acid but top up only with chemically pure distilled water.

Generator

Every 10.000 kms. (6000 miles), the commutator should be cleaned with a clean cloth slightly moistened in petrol.

Copper or carbon dust which may have deposited in between the rotor blades can be removed by compressed air.

When cleaning the commutator check also the condition of the brushes and if chipped or worn, replace them ensuring that they make good contact and are flush with the commutator, or else this may get damaged.

N.B. - Replacement of brushes must be made with original parts and preferably by fully qualified electricians.

Regulator unit

The regulator is sealed to prevent it from being tampered with. In case of failures or incorrect operation, it should be sent for inspection to the makers or their agents. Replacements must be made with original parts bearing the same number.

Starter motor

Clean its commutator every 20.000 kms. or so (12.000 miles). To clean it use a petrol moistened cloth.

Carbon or copper dust between the rotor blades can easily be removed by compressed air. Check condition of the brushes and if any are worn or chipped, replace them. To avoid damage to the commutator, the brushes should be in perfect even contact with it. Use only original parts and have this job done preferably by qualified electricians.

Horn

The 12 V horn does not require any maintenance. In case of irregular operation have it seen to by competent electricians or replace it.

Light switch and horn button

Does not require any adjustment but in case of faulty operation, remove its cover and check all contacts, screwing down tightly all wires.

Starter button

Does not require any adjustment but in case of faulty operation, check all contacts.

Headlight US version

Of sealed beam type.

Lamps

- Headlight: sealed beam insert 168 mm. (6.6") 45/40 W
- Tail light: two filament, round 20/5 W
- Speedometer: round 3 W
- Dimmer indicator: round 3 W
- Ammeter: round 3 W
- Neutral indicator: round 3 W
- Oil pressure: round 3 W

Tail lamp

Of approved type on both US and European versions.



Fuses

9 fuses of 25 Amp. protect all the battery fed electrics i.e. ignition switch, speedometer, warning lights, stop light, and horn. If a fuse blows, trace and correct the cause, and replace with a similar fuse.

Cables

Check these over occasionally and ensure their perfect condition. Replace if necessary.

N.B. - If any extra accessories are added, ensure they are connected to the terminals which can stand the load and not going beyond the capacity of the terminal itself and/or the H.T. leads, thus preventing possible damage to the electric system.

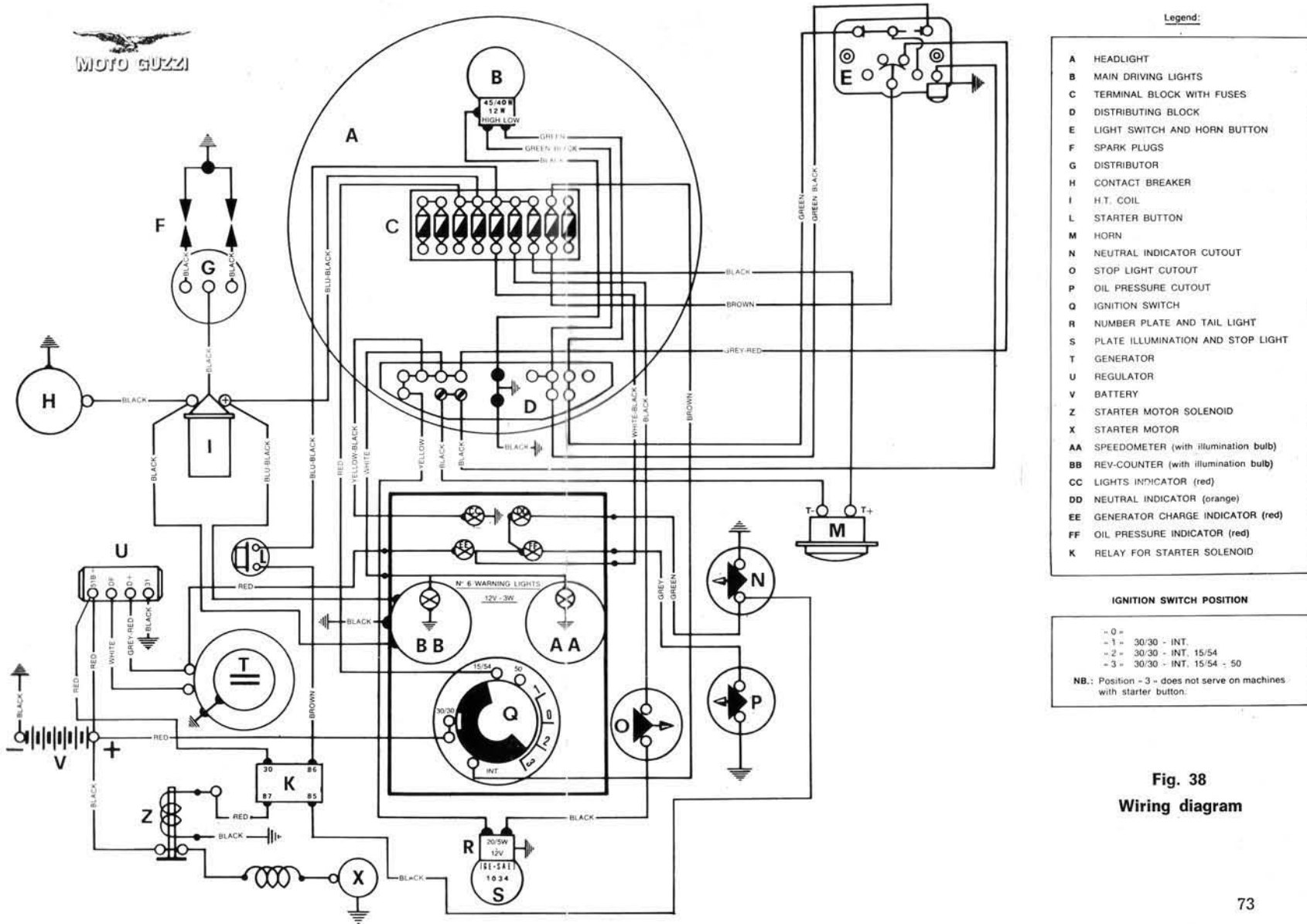

Legend:

- A HEADLIGHT
- B MAIN DRIVING LIGHTS
- C TERMINAL BLOCK WITH FUSES
- D DISTRIBUTING BLOCK
- E LIGHT SWITCH AND HORN BUTTON
- F SPARK PLUGS
- G DISTRIBUTOR
- H CONTACT BREAKER
- I H.T. COIL
- L STARTER BUTTON
- M HORN
- N NEUTRAL INDICATOR CUTOUT
- O STOP LIGHT CUTOUT
- P OIL PRESSURE CUTOUT
- Q IGNITION SWITCH
- R NUMBER PLATE AND TAIL LIGHT
- S PLATE ILLUMINATION AND STOP LIGHT
- T GENERATOR
- U REGULATOR
- V BATTERY
- Z STARTER MOTOR SOLENOID
- X STARTER MOTOR
- AA SPEEDOMETER (with illumination bulb)
- BB REV-COUNTER (with illumination bulb)
- CC LIGHTS INDICATOR (red)
- DD NEUTRAL INDICATOR (orange)
- EE GENERATOR CHARGE INDICATOR (red)
- FF OIL PRESSURE INDICATOR (red)
- K RELAY FOR STARTER SOLENOID

IGNITION SWITCH POSITION

- 0 -
- 1 - 30/30 - INT.
- 2 - 30/30 - INT. 15/54
- 3 - 30/30 - INT. 15/54 - 50

NB.: Position - 3 - does not serve on machines with starter button.

Fig. 38
Wiring diagram